

NOBEL HOME LIFT

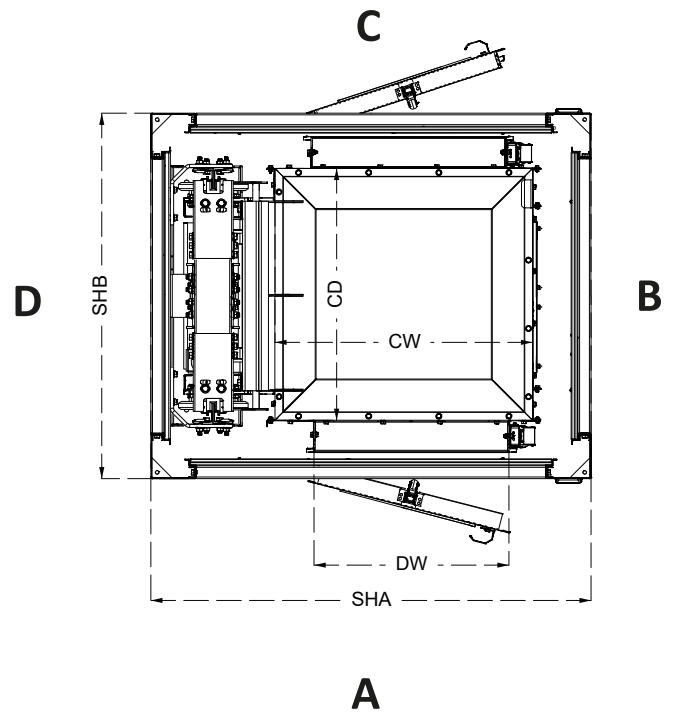

NOBEL HOME LIFT - TEKNİK

GİRİŞ ÇIKIŞ YÖNÜ	A TİPİ		B TİPİ		C TİPİ		D TİPİ	
	AYNI YÖN	KARŞILIKLI	AYNI YÖN	KARŞILIKLI	AYNI YÖN	KARŞILIKLI	AYNI YÖN	KARŞILIKLI
EN--SHA	1125	1325	1225	1425	1325	1525	1425	1625
BOY--SHB	1125	1125	1225	1225	1325	1325	1425	1425
PİT--P	150		150		150		150	
SON KAT H--TFH	2700		2700		2700		2700	
KAPI--DW	600		700		800		900	
KABİN EN--CW	835	765	935	865	1035	965	1135	1065
KABİN BOY--CD	525	750	625	850	725	950	825	1050
KABİN YÜKSEKLİĞİ	2000		2000		2000		2000	
KAPASİTE	240 (kg)		240 (kg)		320 (kg)		320 (kg)	
HIZ	0,15 - 0,30 (m/sn)		0,15 - 0,30 (m/sn)		0,15 - 0,30 (m/sn)		0,15 - 0,30 (m/sn)	
DURAK	2 - 5		2 - 5		2 - 5		2 - 5	
MOTOR	4,7 (kW)		4,7 (kW)		4,7 (kW)		4,7 (kW)	
KABLO KESİTİ	5x4		5x4		5x4		5x4	

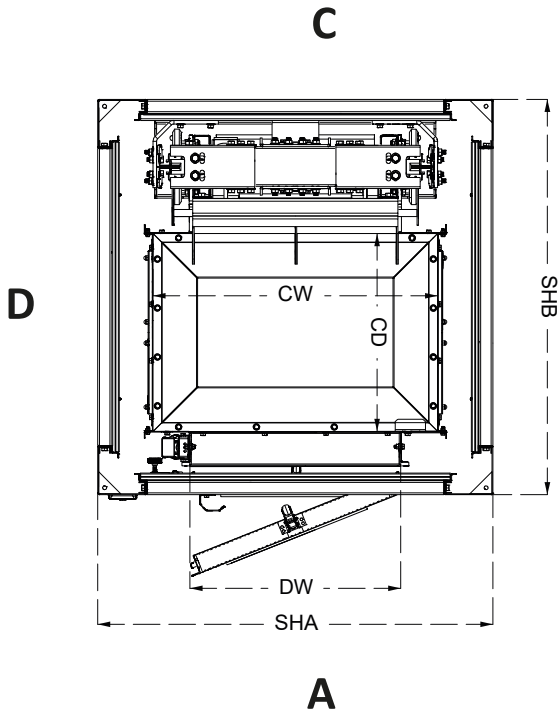

NOBEL HOME LIFT - TEKNİK

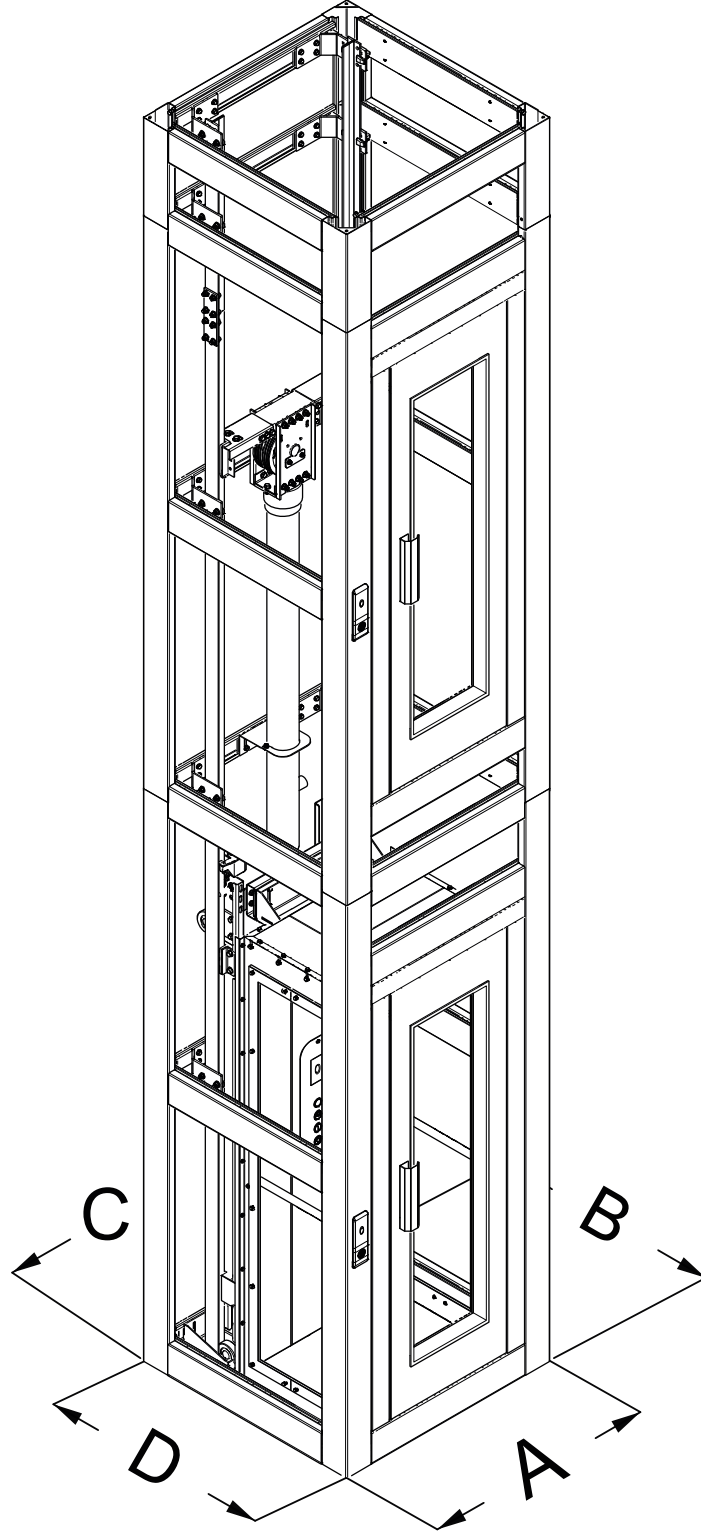

www.cenka.com.tr

İstanbul: 0212 474 99 46 - Sefaköy San. Sit. 13. Blok, No: 11-13-15-17, Başakşehir
Bodrum: 0252 363 09 09 - Atatürk Bulvarı, Pamir İş Merkezi, 114/G2, Konack
Cenka Asansör Makina İmalat, İthalat, İhracat Sanayi ve Ticaret Limited Şirketi

NOBEL HOME LIFT - TEKNİK

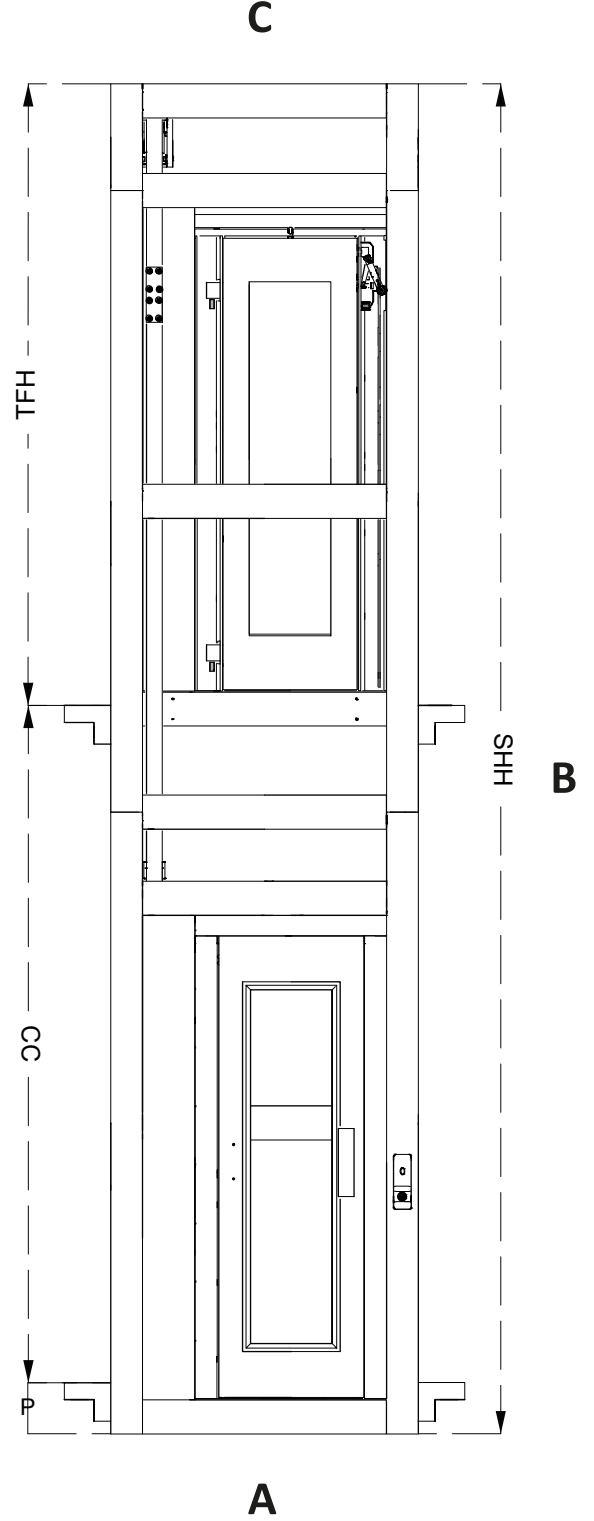
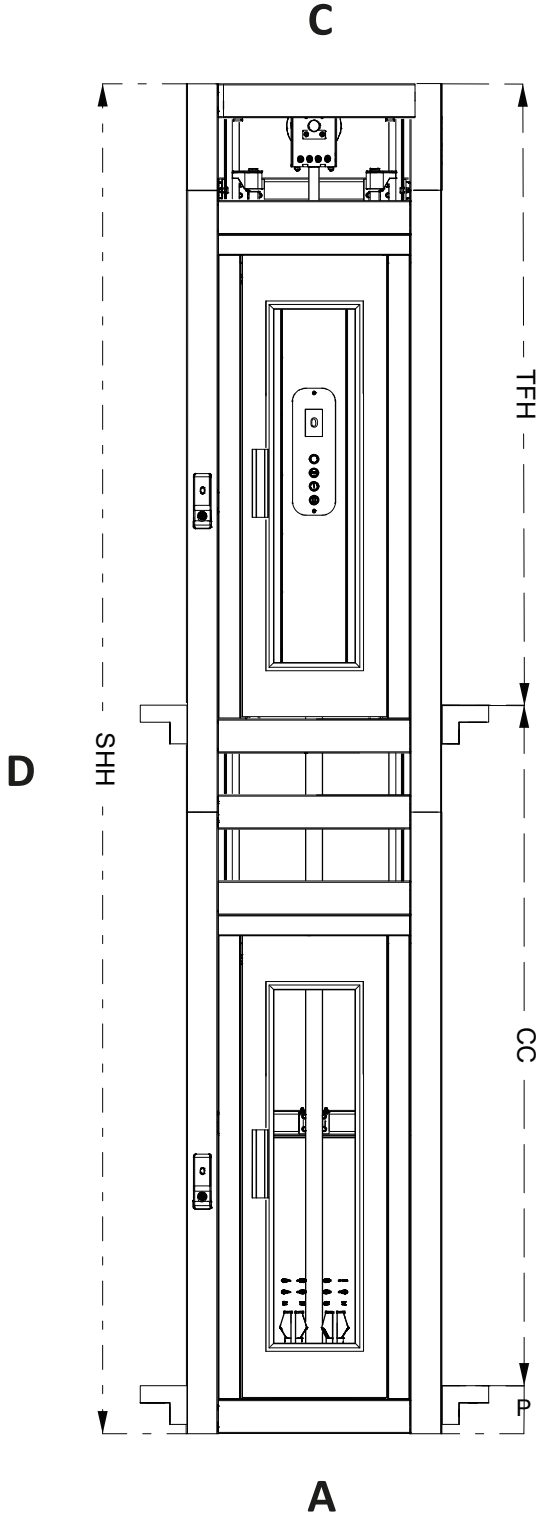

NOBEL HOME LIFT - SİPARİŞ DONANIMLARI



R E N K



1013



7016



7039



8008

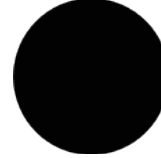

9005



9016

K A P I K O L U



KK-1



KK-2



KK-3

D İ Ő K A S E T



BTG-1



BTG-2



BTG-3



BTG-4



www.cenka.com.tr

İstanbul: 0212 474 99 46 - Sefaköy San. Sit. 13. Blok, No: 11-13-15-17, Başakşehir
Bodrum: 0252 363 09 09 - Atatürk Bulvarı, Pamir İş Merkezi, 114/G2, Konack
Cenka Asansör Makina İmalat, İthalat, İhracat Sanayi ve Ticaret Limited Şirketi

NOBEL HOME LIFT - SİPARİŞ DONANIMLARI



T A V A N



TVN-1



TVN-2



TVN-3



TVN-4

C A M

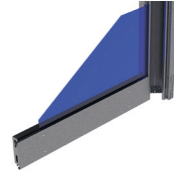

CM-1

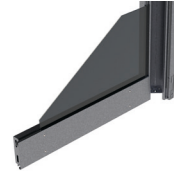

CM-2

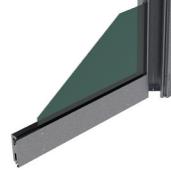

CM-3



CM-4

Z E M İ N

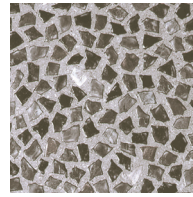

TBN-1



TBN-2

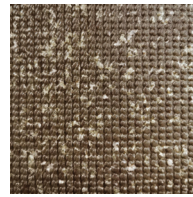

TBN-3

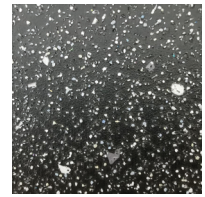















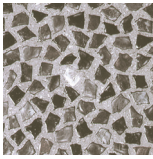

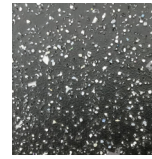
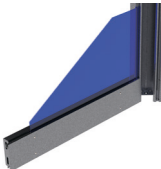

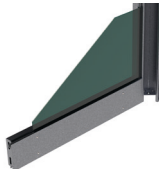









TBN-4



www.cenka.com.tr

İstanbul: 0212 474 99 46 - Sefaköy San. Sit. 13. Blok, No: 11-13-15-17, Başakşehir
Bodrum: 0252 363 09 09 - Atatürk Bulvarı, Pamir İş Merkezi, 114/G2, Konack
Cenka Asansör Makina İmalat, İthalat, İhracat Sanayi ve Ticaret Limited Şirketi

NOBEL HOME LIFT - SİPARİŞ FORMU

TAVAN								
	TVN-1	<input type="checkbox"/>	TVN-2	<input type="checkbox"/>	TVN-3	<input type="checkbox"/>	TVN-4	<input type="checkbox"/>
ZEMİN								
	TBN-1	<input type="checkbox"/>	TBN-2	<input type="checkbox"/>	TBN-3	<input type="checkbox"/>	TBN-4	<input type="checkbox"/>
CAM								
	CM-1	<input type="checkbox"/>	CM-2	<input type="checkbox"/>	CM-3	<input type="checkbox"/>	CM-4	<input type="checkbox"/>
DIŞ KASET								
	BTG-1	<input type="checkbox"/>	BTG-2	<input type="checkbox"/>	BTG-3	<input type="checkbox"/>	BTG-4	<input type="checkbox"/>
KAPI KOLU								
	KK-1	<input type="checkbox"/>	KK-2	<input type="checkbox"/>	KK-3	<input type="checkbox"/>		
RAL KODU (elektrostatik toz boya)								
	1013	7016	7039	8008	9005	9016		
AHŞAP DESENLİ KAPLAMA								
	ADK-1	ADK-2	ADK-3	ADK-4	ADK-5	ADK-6		

Tercih Kutusu
 Tercih Edilen

